

NAHT
SUTURE
SUTURE
SUTURA
SUTURA





CASTROVIEJO



18.0800 14 cm
18.0802 18 cm
18.0804 22 cm
 18.1800 14 cm
 18.1802 18 cm
 18.1804 22 cm



18.0810
18.0812
18.0814
 18.1810
 18.1812
 18.1814



18.0801 14 cm
18.0803 18 cm
18.0805 22 cm
 18.1801 14 cm
 18.1803 18 cm
 18.1805 22 cm



18.0811
18.0813
18.0815
 18.1811
 18.1813
 18.1815



CASTROVIEJO



CASTROVIEJO
 18.0840 13 cm



CASTROVIEJO
 18.1840 13 cm



BOYNTON
 18.1850 12 cm

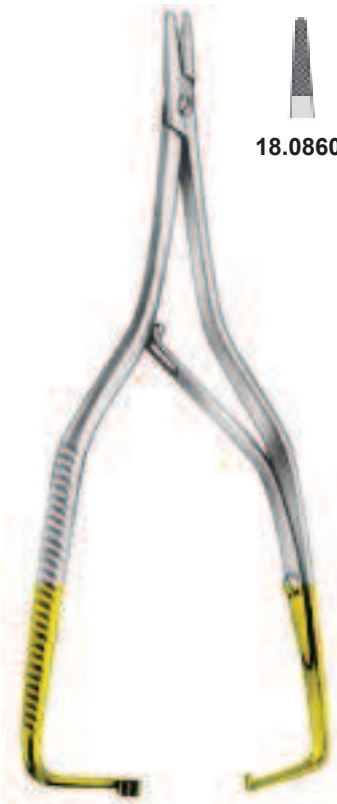

18.0860

ARRUGA
16 cm



18.0861



18.1860

ARRUGA
16 cm



18.1861



18.1864

ARRUGA
14 cm



18.1865



KALT
18.0870 14 cm



KALT
18.1870 14 cm



KALT-ARRUGA
18.1875 14 cm



STEVENS
 18.1880 11 cm



STEVENS
 18.1884 13 cm
 18.1886 15 cm



COHAN
 18.1940
 7,5 cm
 gebogen ohne Sperre
 curved without lock
 courbe sans arrêt
 curvo sin cierre
 curvo senza caramagliera



COHAN
 18.1942
 7,5 cm
 gebogen mit Sperre
 curved with lock
 courbe avec arrêt
 curvo con cierre
 curvo con caramagliera



18.1912



18.1913

BARRAQUER-TROUTMANN
 10 cm



18.1914



18.1915

BARRAQUER-TROUTMANN
 10 cm



BARRAQUER
 18.1910 13 cm



BARRAQUER
 18.1911 11 cm



BARRAQUER
 18.1900
 12 cm



BARRAQUER
 18.1901
 12 cm



BARRAQUER
 18.1902
 12 cm



BARRAQUER
 18.1903
 12 cm



BARRAQUER
 18.1917
 14 cm



18.1920 18.1921

**CASTROVIEJO-
 MICRO**
 9 cm



18.1924 18.1925

**CASTROVIEJO-
 MICRO**
 9 cm



18.1930 18.1931

**CASTROVIEJO-
 MICRO**
 14 cm



18.1931



18.1932 18.1933

**CASTROVIEJO-
 MICRO**
 14 cm



18.1932



18.1933



28.3100
15 cm



28.3101
15 cm



28.3102
15 cm



28.3103
15 cm

REILL

REILL



28.3130
12,5 cm / Ø 7 mm
gerade
straight
droit
recto
retto

28.3131
12,5 cm / Ø 7 mm
gebogen
curved
courbe
curvo
curvo

ohne Sperre
without lock
sens arrêt
sin cierre
senza caramagliera



28.3132
12,5 cm / Ø 7 mm
gerade
straight
droit
recto
retto

28.3133
12,5 cm / Ø 7 mm
gebogen
curved
courbe
curvo
curvo

mit Sperre
with lock
avec arrêt
con cierre
con caramagliera



28.3140
15 cm / Ø 8 mm

28.3150
18 cm / Ø 8mm

gerade
straight
droit
recto
retto



28.3141
15 cm / Ø 8 mm

28.3151
18 cm / Ø 8 mm

gebogen
curved
courbe
curvo
curvo



28.3142
15 cm / Ø 8 mm

28.3152
18 cm / Ø 8 mm

gerade mit Sperre
straight with lock
droit avec arrêt
recto con cierre
retto con caramagliera



28.3143
15 cm / Ø 8 mm

28.3153
18 cm / Ø 8 mm

gebogen mit Sperre
curved with lock
courbe avec arrêt
curvo con cierre
curvo con caramagliera



mit Sperre
with lock
avec arrêt
con cierre
con caramagliera

21 cm

28.3154
gerade
straight
droit
recto
retto

28.3155
gebogen
curved
courbe
curvo
curvo



mit Sperre
with lock
avec arrêt
con cierre
con caramagliera

23 cm

28.3156
gerade
straight
droit
recto
retto

28.3157
gebogen
curved
courbe
curvo
curvo



15 cm

28.3242

gerade
straight
droit
recto
retto

28.3243

gebogen
curved
courbe
curvo
curvo



18 cm

28.3252

gerade
straight
droit
recto
retto

28.3253

gebogen
curved
courbe
curvo
curvo



21 cm

28.3254

gerade
straight
droit
recto
retto

28.3255

gebogen
curved
courbe
curvo
curvo



23 cm

28.3256

gerade
straight
droit
recto
retto

28.3257

gebogen
curved
courbe
curvo
curvo



JACOBSON



- 28.3400
- 18,5 cm
- 28.3402
- 21 cm
- 28.3404
- 23 cm



JACOBSON



- 28.3406
- 18,5 cm
- 28.3408
- 21 cm



MIKRO-NADELHALTER



- 28.3450
- 23 cm



- 28.3451
- 23 cm



Diamantbeschichtete Spitzen
Diamond coated tips
Avec bouts de diamant
Puntas con cascós de diamante
Morsi con rivestimento di diamante



Maul 2 mm breit gerieft
Jaws 2 mm wide serrated
mors 2 mm, dentelées
boca 2 mm, dentadas
morso 2 mm, dentate

28.3662

18 cm / 10 mm

28.3664

21 cm / 10 mm

GREGORY



28.3662D

18 cm / 10 mm

28.3664D

21 cm / 10 mm













GREGORY













TITANIUM



Diamantbeschichtete Spitzen
 Diamond coated tips
 Avec bouts de diamant
 Puntas con cascos de diamante
 Morsi con rivestimento di diamante

ohne Sperre
 without lock
 sens arrêt
 sin cierre
 senza caramagliera

							
0,4mm				0,4mm			
15 cm	28.3600	28.3600SD	28.3600S	15 cm	28.3601	28.3601SD	28.3601S
18 cm	28.3602	28.3602SD	28.3602S	18 cm	28.3603	28.3603SD	28.3603S
21 cm	28.3604	28.3604SD	28.3604S	21 cm	28.3605	28.3605SD	28.3605S
23 cm	28.3606	28.3606SD	28.3606S	23 cm	28.3607	28.3607SD	28.3607S

							
0,8mm				0,8mm			
15 cm	28.3610	28.3610SD	28.3610S	15 cm	28.3611	28.3611SD	28.3611S
18 cm	28.3612	28.3612SD	28.3612S	18 cm	28.3613	28.3613SD	28.3613S
21 cm	28.3614	28.3614SD	28.3614S	21 cm	28.3615	28.3615SD	28.3615S
23 cm	28.3616	28.3616SD	28.3616S	23 cm	28.3617	28.3617SD	28.3617S

TITANIUM







TITANIUM







TITANIUM















Diamantbeschichtete Spitzen
 Diamond coated tips
 Avec bouts de diamant
 Puntas con cascos de diamante
 Morsi con rivestimento di diamante

mit Sperre
 with lock
 avec arrêt
 con cierre
 con arresto

			
0,4mm			
15 cm	28.3630	28.3630SD	28.3630S
18 cm	28.3632	28.3632SD	28.3632S
21 cm	28.3634	28.3634SD	28.3634S
23 cm	28.3636	28.3636SD	28.3636S

			
0,4mm			
15 cm	28.3631	28.3631SD	28.3631S
18 cm	28.3633	28.3633SD	28.3633S
21 cm	28.3635	28.3635SD	28.3635S
23 cm	28.3637	28.3637SD	28.3637S

			
0,8mm			
15 cm	28.3640	28.3640SD	28.3640S
18 cm	28.3642	28.3642SD	28.3642S
21 cm	28.3644	28.3644SD	28.3644S
23 cm	28.3646	28.3646SD	28.3646S

			
0,8mm			
15 cm	28.3641	28.3641SD	28.3640S
18 cm	28.3643	28.3643SD	28.3642S
21 cm	28.3645	28.3645SD	28.3644S
23 cm	28.3647	28.3647SD	28.3647S

TITANIUM

TITANIUM





TITANIUM



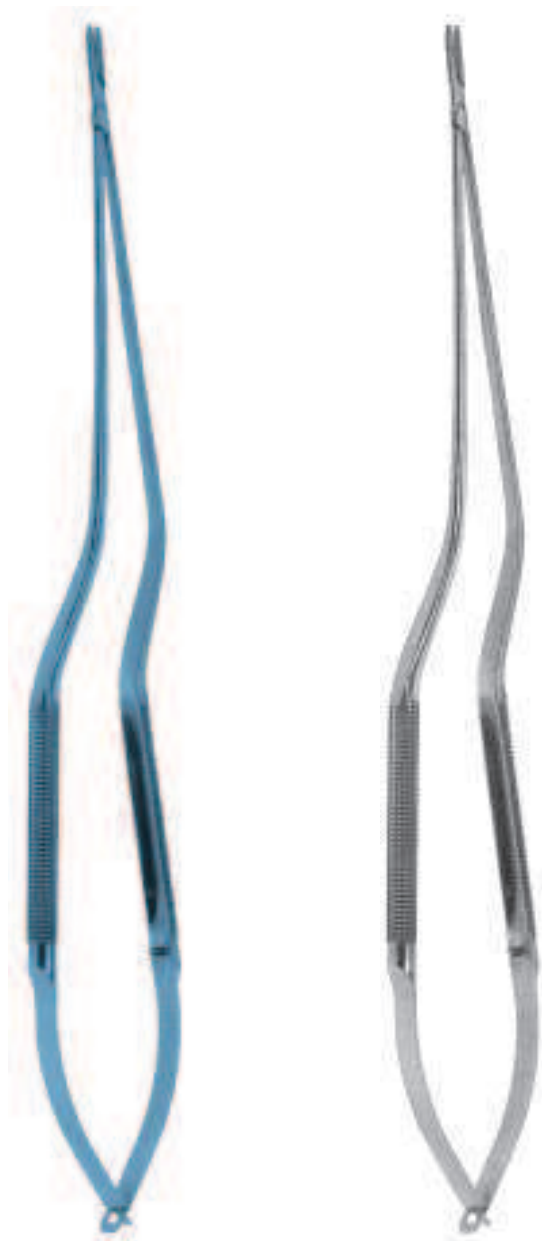



Diamantbeschichtete Spitzen
 Diamond coated tips
 Avec bouts de diamant
 Puntas con cascos de diamante
 Morsi con rivestimento di diamante

ohne Sperre
 without lock
 sans arrêt
 sin cierre
 senza caramagliera







1 mm				
21 cm	28.3700	28.3700SD	28.3700S	

1 mm				
21 cm	28.3701	28.3701SD	28.3701S	

1 mm				
23 cm	28.3702	28.3702SD	28.3702S	

TITANIUM

1 mm				
23 cm	28.3703	28.3703SD	28.3703S	

TITANIUM



28.3504 20,0 cm
28.3506 22,0 cm



28.3501 16,0 cm
28.3505 20,0 cm
28.3507 22,0 cm
28.3509 24,0 cm



28.3520 16,0 cm
28.3522 18,0 cm



28.3521 16,0 cm
28.3523 18,0 cm

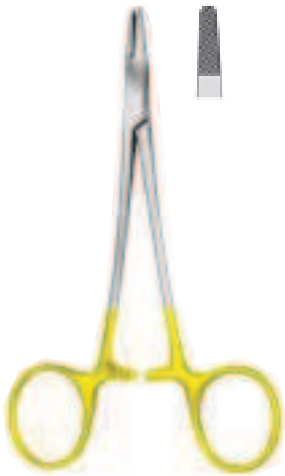

DERF
 18.0010 12 cm

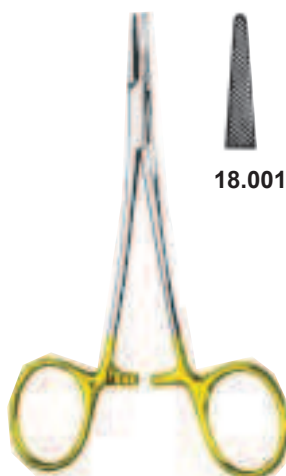

HALSEY-MICRO
 12 cm

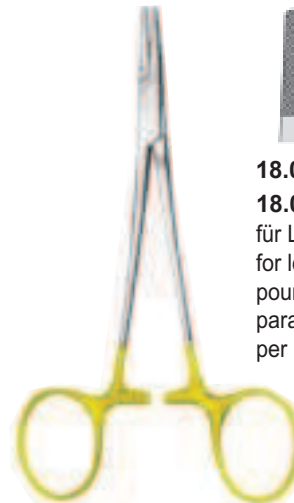

HALSEY
 13 cm



WEBSTER
 13 cm



BAUMGARTNER
 18.0030 14 cm



KILNER
 13 cm

18.0016

18.0018
 glatt
 smooth
 lisse
 lisa
 liscio

18.0020
 18.0020 L
 für Linkshänder
 for left-handers
 pour gauchers
 para zurdos
 per mono sinistra

18.0025
 glatt
 smooth
 lisse
 lisa
 liscio

18.0026
 glatt
 smooth
 lisse
 lisa
 liscio

18.0029

18.0040

18.0042
 glatt
 smooth
 lisse
 lisa
 liscio

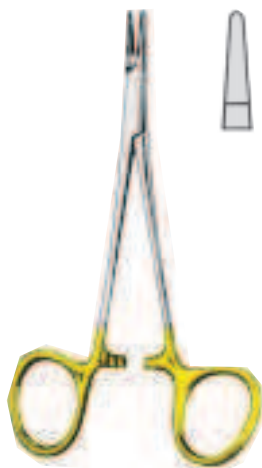

NEIVERT
 18.0050 12 cm



BABY-CRILE-WOOD
 18.0069 15 cm

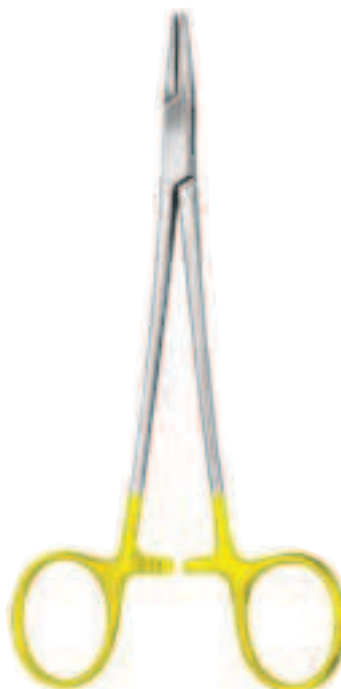

CRILE-WOOD

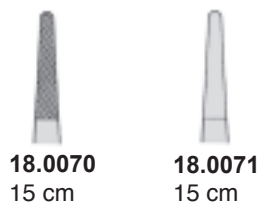

18.0070
 15 cm

18.0071
 15 cm

18.0070L
 15 cm
 für Linkshänder
 for left-handers
 pour gauchers
 para zurdos
 per mono sinistra



18.0072
 18 cm

18.0074
 20 cm

18.0076
 23 cm

18.0072L
 18 cm

18.0074L
 20 cm

18.0076L
 23 cm

für Linkshänder / for left-handers / pour gauchers
 para zurdos / per mono sinistra

TITANIUM

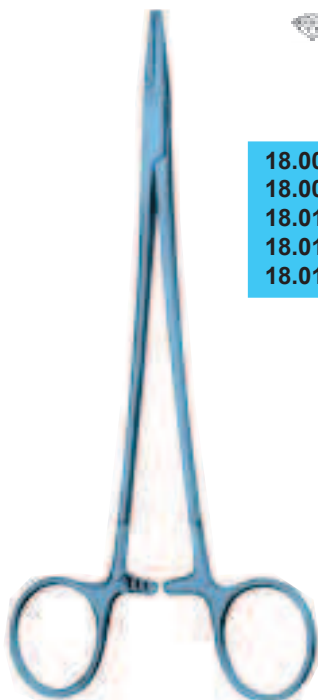

MICRO-VASCULAR



- 18.0016TD** 12,5 cm
- 18.0070TD** 14,5 cm
- 18.0100TD** 17,5 cm
- 18.0102TD** 19,5 cm
- 18.0104TD** 22,5 cm



Diamantbeschichtete Spitzen
 Diamond coated tips
 Avec bouts de diamant
 Puntas con cascós de diamante
 Morsi con rivestimento di diamante

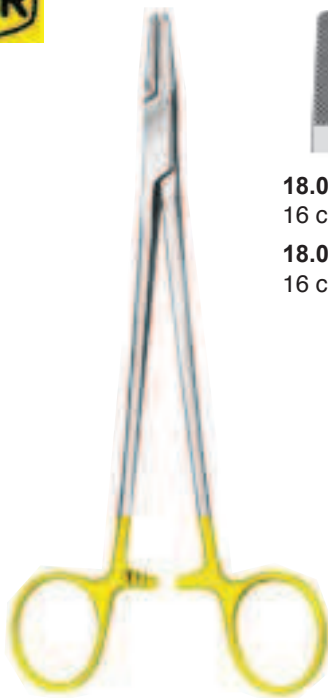

MAYO-HEGAR



18.0080
16 cm



18.0082
18 cm



18.0084
20 cm



18.0086
24 cm



18.0088
26 cm

18.0080L
16 cm

18.0082L
18 cm

18.0084L
20 cm

18.0086L
24 cm

18.0088L
26 cm

für Linkshänder / for left-handers / pour gauchers / para zurdos / per mono sinistra



18.0090
30 cm



18.0092
35 cm



18.0094
37 cm



18.0096
40 cm

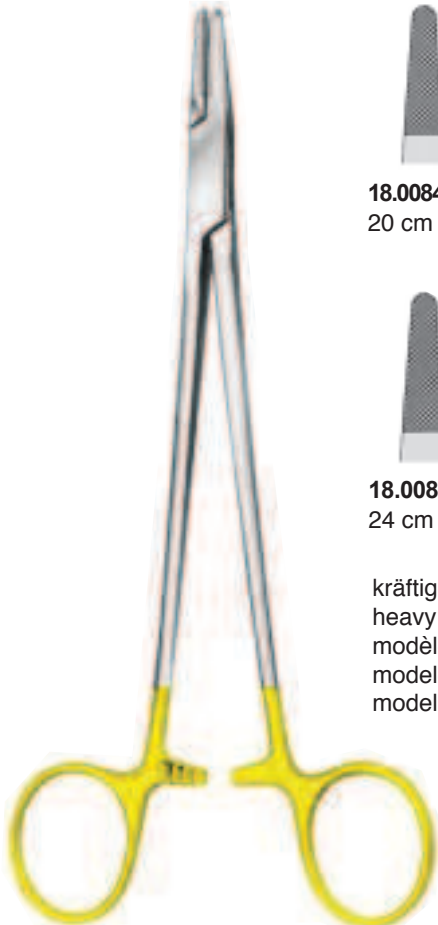

MAYO-HEGAR



18.0084HP
20 cm



18.0086HP
24 cm

kräftige Modelle
 heavy patterns
 modèles forts
 modelos robustos
 modelli robusti



18.0100
18 cm



18.0102
20 cm



18.0104
23 cm



DEBAKEY



18.0106
26 cm



18.0108
30 cm



18.0110
37 cm



Diamantbeschichtete Spitzen
 Diamond coated tips
 Avec bouts de diamant
 Puntas con cascos de diamante
 Morsi con rivestimento di diamante



DEBAKEY-SELECT

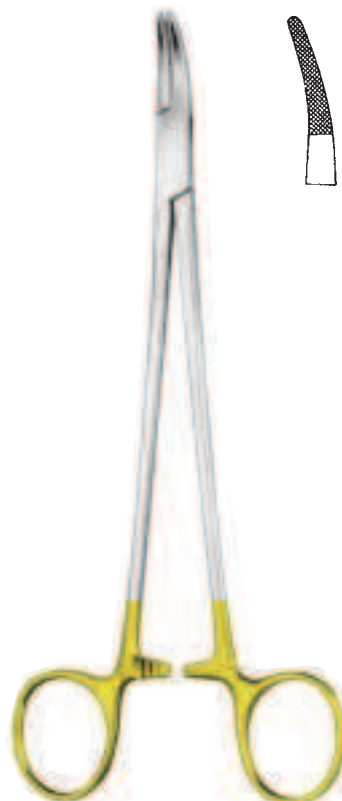

JULIAN

18.0113 20 cm
18.0115 23 cm

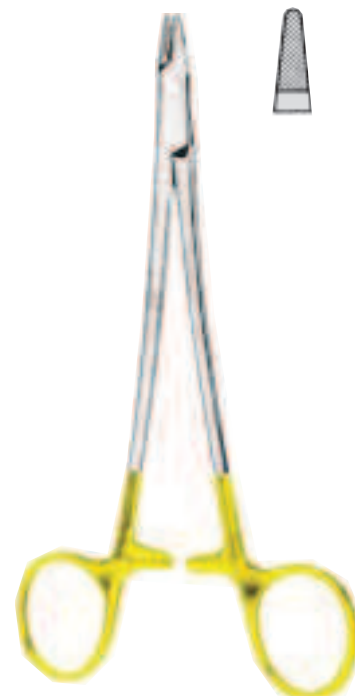

NEW ORLEANS

18.0120
18 cm

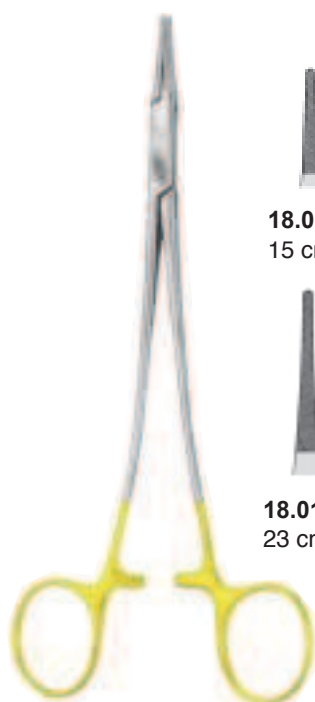

MICRO-VASCULAR

18.0130
15 cm



18.0136
23 cm

18.0132
18 cm



18.0138
25 cm

18.0134
20 cm



MICRO-VASCULAR-SELECT



18.0130D
15 cm

18.0136D
23 cm

18.0132D
18 cm

18.0138D
25 cm

18.0134D
20 cm



18.0134D
20 cm



18.0134D
20 cm

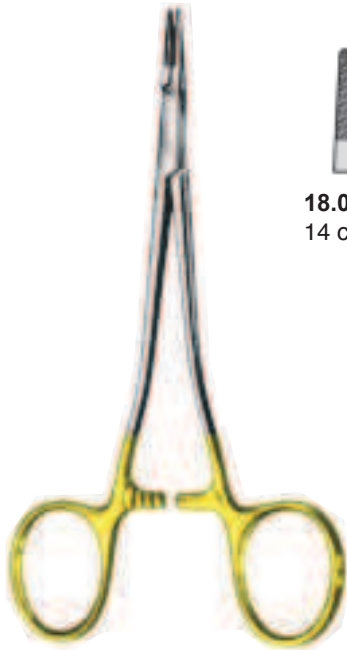

18.0610
14 cm



18.0612
20 cm

INTRACARDIAC



18.0140
18 cm

BERRY STERNAL



TOENNIS
18.0142 18 cm
18.0144 20 cm



18.0146
18 cm



18.0148
20 cm

TOENNIS-RYDER



LANGENBECK

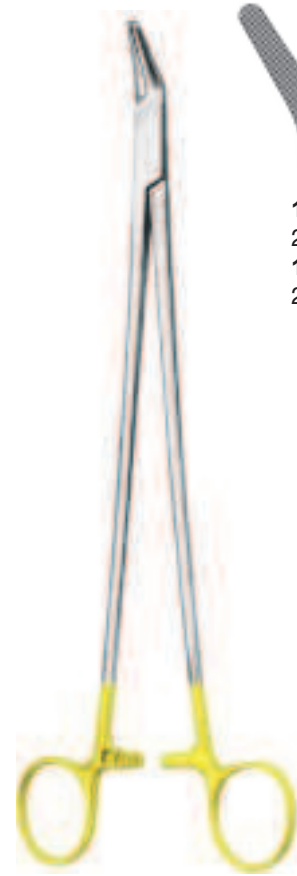
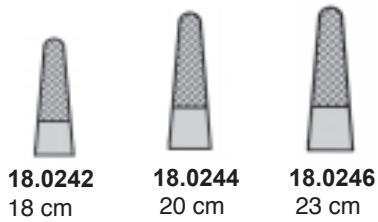

FINOCHIETTO

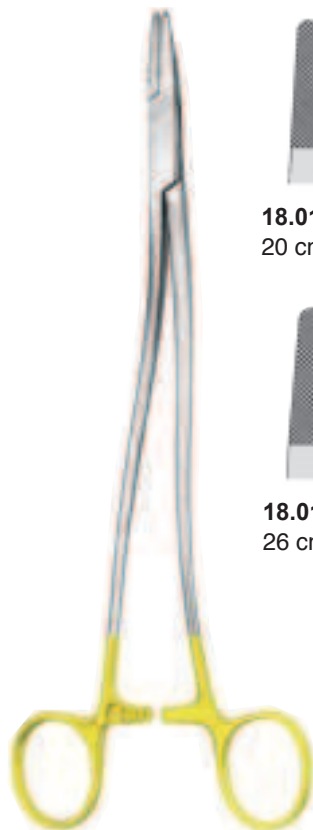
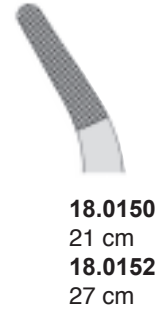

BOZEMANN

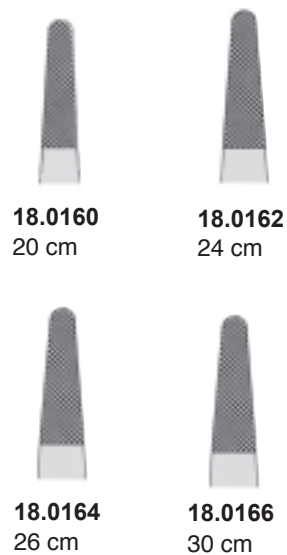

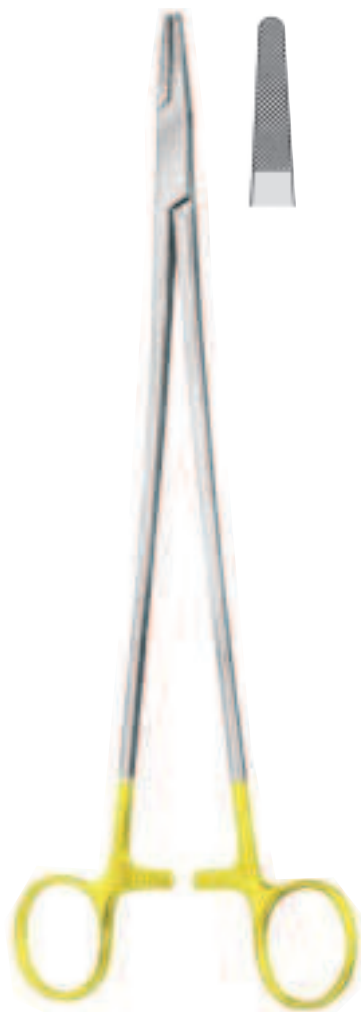

MASSON
18.0170 27 cm

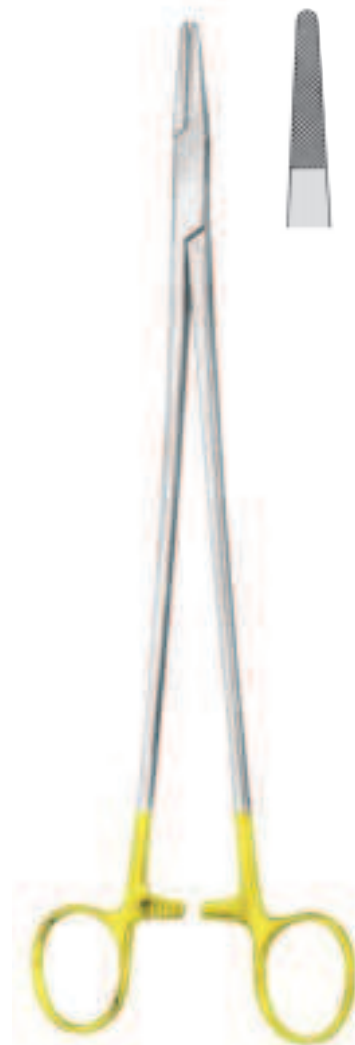

WANGENSTEEN
18.0180 28 cm

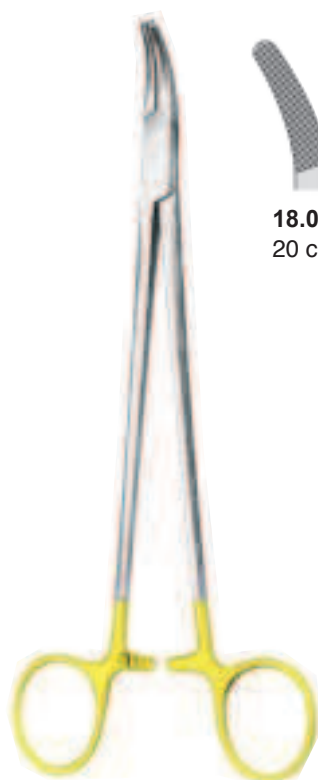

HEANEY



18.0190
20 cm



18.0192
24 cm



18.0194
26 cm

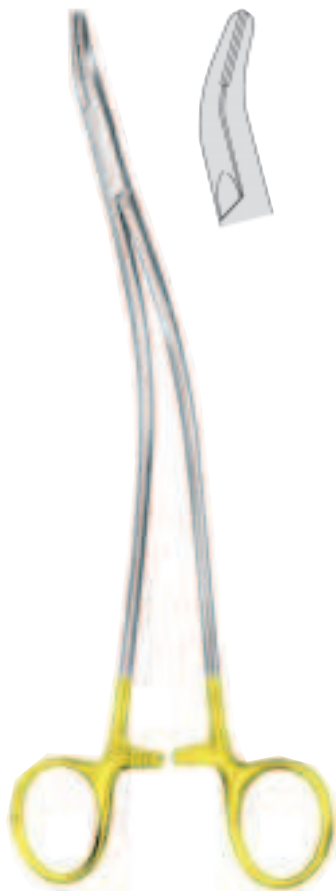

STRATTE



18.0202
21 cm



18.0204
23 cm



SAROT



18.0210
15 cm



18.0212
18 cm



18.0214
27 cm



NAUNTON-MORGAN



18.0220
26 cm



MATHIEU

18.0250
14 cm

18.0252
17 cm

18.0254
20 cm

18.0256
24 cm

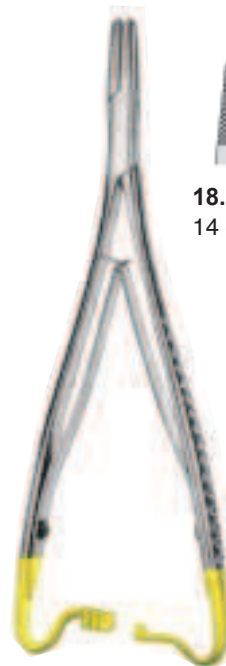

MATHIEU

18.0260
14 cm

18.0262
17 cm

18.0264
20 cm

18.0266
23 cm

mit Innensperre
 with inside ratchet
 avec crémaillère interne
 con cremagliera interna



MATHIEU-KOCHER

18.0270
14 cm

18.0272
17 cm

18.0274
20 cm



LICHTENBERG

18.0280
20 cm



HÖSEL
18.0286 20 cm
18.0288 25 cm

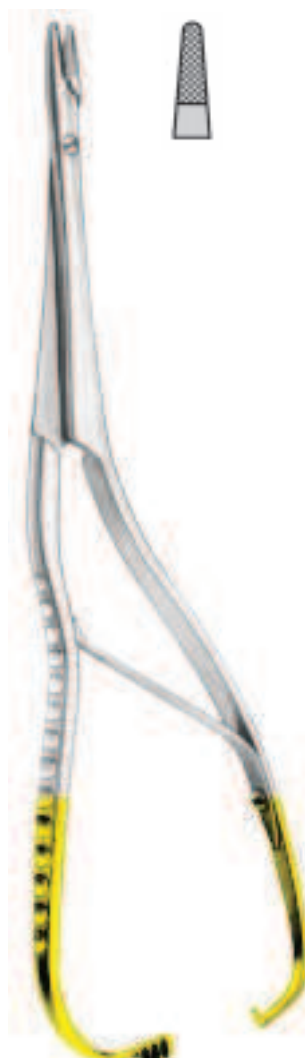

HÖSEL
18.0289 25 cm



FOSTER-GILLIES
18.0310 12 cm
18.0310L 12 cm
für Linkshänder
for left-handers
pour gauchers
para zurdos
per mano sinistra



18.0320
15,5 cm

GILLIES-MINI

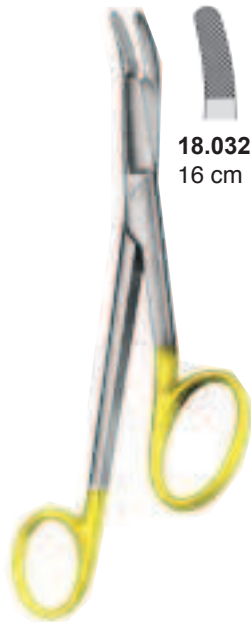

18.0322
16 cm

GILLIES



18.0330 12 cm
18.0330L 12 cm
 für Linkshänder
 for left-handers
 pour gauchers
 para zurdos
 per mano sinistra

OLSEN-HEGAR

18.0331 12 cm
 glatt
 smooth
 lisse
 lisa



18.0332
14 cm

18.0334
16,5 cm

18.0336
18,5 cm

OLSEN-HEGAR



18.0340
12 cm
 gerieft
 serrated
 strié
 estriada
 con striatura

KAYE

18.0341
12 cm
 glatt
 smooth
 lisse
 lisa
 liscio

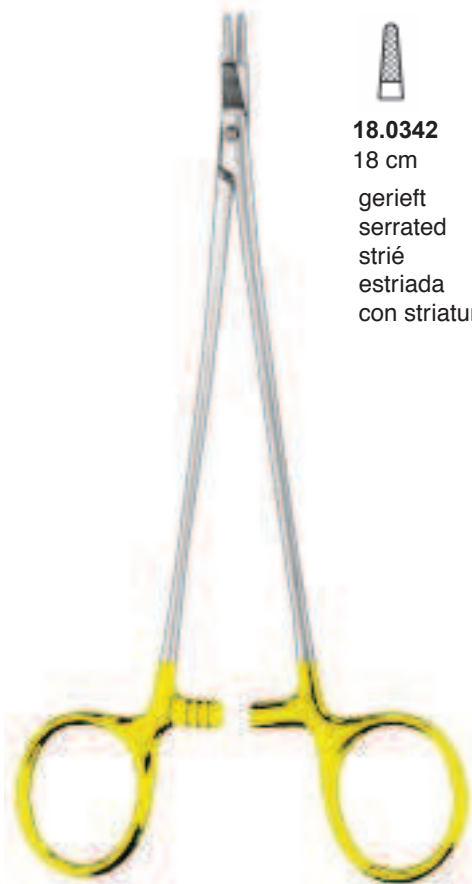

KAYE



18.0342
 18 cm
 gerieft
 serrated
 strié
 estriada
 con striatura



18.0343
 18 cm
 glatt
 smooth
 lisse
 lisa
 liscio

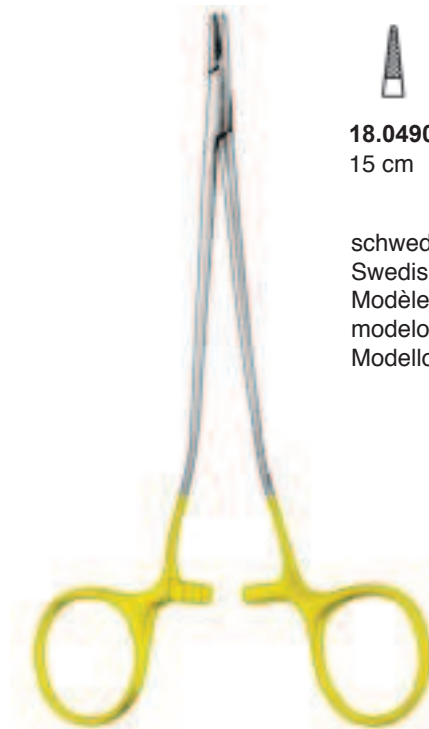

PRO-MED



18.0490
 15 cm

schwedisches Modell
 Swedish model
 Modèle suédoise
 modelo sueco
 Modello svedese

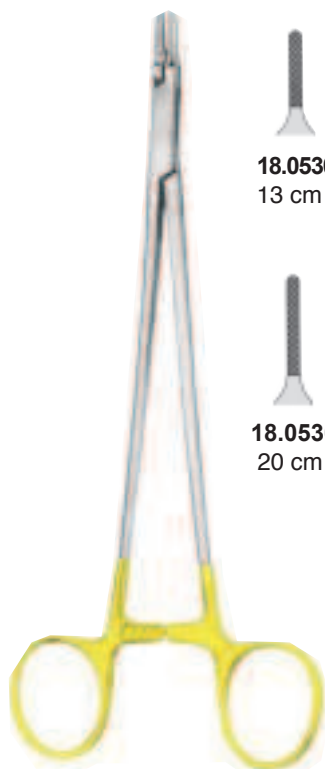

RYDER



18.0530
 13 cm



18.0532
 15 cm



18.0534
 18 cm



18.0536
 20 cm



18.0538
 23 cm



18.0540
 26 cm

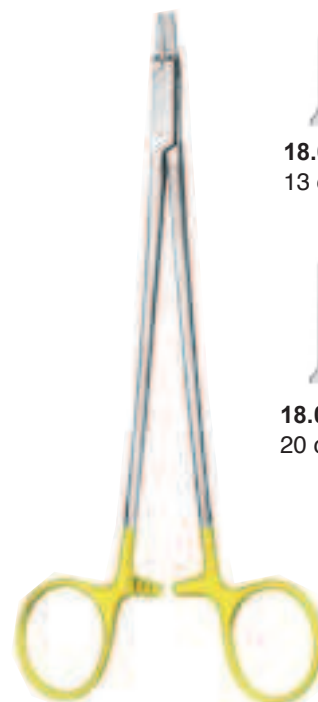

RYDER-MINI



18.0550
 13 cm



18.0552
 15 cm



18.0554
 18 cm



18.0556
 20 cm



18.0558
 23 cm



18.0560
 25 cm



Diamantbeschichtete Spitzen
Diamond coated tips
Avec bouts de diamant
Puntas con cascós de diamante
Morsi con rivestimento di diamante



RYDER-MINI-SELECT

18.0552D 15 cm
18.0554D 18 cm
18.0556D 20 cm
18.0558D 23 cm



DIETHRICH

18.0600 18 cm
18.0602 20 cm
18.0604 23 cm
18.0606 26 cm

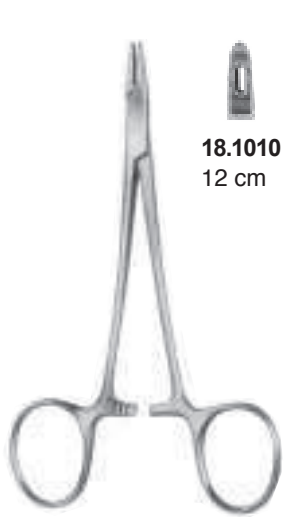

18.1010
12 cm

DERF



18.1012
12,5 cm



COLLIER
18.1015 12,5 cm



HALSEY
13 cm



18.1020



18.1025



WEBSTER
18.1026 13 cm



BAUMGARTNER
18.1030 14 cm



DOYEN
18.1035 12,5 cm



KILNER
18.1040 13 cm



Maul glatt mit Spezialkehle
 Smooth jaws, with special groove
 Mâchoires lisses, avec cannelure spécial
 Bocas lisas, con acanaladura especial
 morso liscio con scannellatura speciale



NEIVERT
 18.1050 12 cm



CRILE
 18.1060 15 cm



CRILE-MURRAY
 18.1065 15 cm



CRILE-WOOD
 18.1070 15 cm



CRILE-WOOD

18.1072
 18 cm

18.1074
 20 cm

18.1076
 23 cm

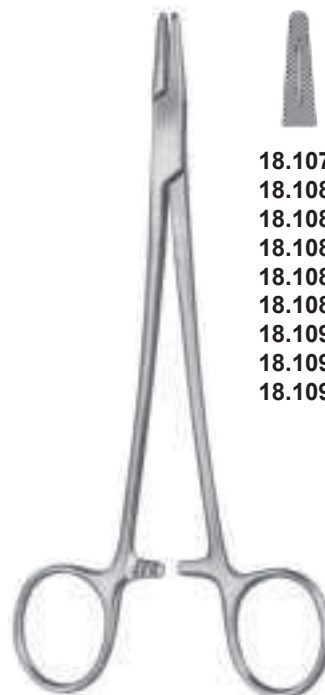

MAYO-HEGAR

- 18.1078** 14 cm
- 18.1080** 16 cm
- 18.1082** 18 cm
- 18.1084** 20 cm
- 18.1086** 24 cm
- 18.1088** 26 cm
- 18.1090** 30 cm
- 18.1092** 35 cm
- 18.1094** 40 cm



METZENBAUM
18.1100 18 cm



ADSON
18.1110 18 cm



FINOCHIETTO
18.1152 21 cm
18.1154 27 cm



JOHNSON
18.1160 27 cm



JOHNSON
18.1161 20 cm
18.1162 24 cm
18.1164 26 cm



MASSON
18.1170 27 cm



WANGENSTEEN
18.1180 27 cm



HEANEY (HEGAR)
18.1190 20 cm



STRATTE
18.1200 23 cm



SAROT
18.1212 18 cm
18.1214 26 cm



18.1250
14 cm



18.1252
17 cm



18.1254
20 cm



18.1260 14 cm
18.1262 17 cm



mit Innensperre
with inside ratchet
avec crémaillère interne
con cremallera interior
con cremagliera interna

MATHIEU
18.1270 14 cm
18.1272 17 cm
18.1274 20 cm



GILLIES-MINI
18.1320 16 cm



GILLIES
18.1322 15 cm



OLSEN-HEGAR
18.1330 12 cm
18.1330L 12 cm
für Linkshänder/for left-handers/pour gauchers
para zurdos/per mono sinistra



OLSEN-HEGAR
18.1332 14 cm
18.1334 16,5 cm
18.1336 18 cm



MICHEL
18.3000
12 cm



MICHEL
18.3010
12 cm



MICHEL-FINO
18.3015
12 cm



CHILDE
18.3020
14,5 cm



CHILDE
18.3022
17,5 cm



HEGENBARTH
18.3050
12,5 cm



WACHENFELDT
18.3060
12 cm



WACHENFELDT
18.3065
12 cm



mm	1000 Stück/pieces pièces/piezas/pezzi
7,5 x 1,75	18.3071
11 x 2	18.3072
12 x 3	18.3074
14 x 3	18.3075
16 x 3	18.3076
18 x 3	18.3077
20 x 3	18.3078
22 x 3	18.3079

MICHEL

Fadenpinzetten
 Suture Forceps
 Pincès à sutures
 Pinzas para suturas
 Pinze per sutura



COLLIN
 18.3100 14 cm



RICHTER-HEATH
 18.3110 14 cm



OCHSNER
 18.3130 14 cm



CORN
 18.3140 15 cm

18.3150 16 cm/Ø1,6 mm
18.3152 16 cm/Ø2,2 mm

Wundklammerbesteck
Suture Clip Set
Trousse à agrafes
Juego de agrafes
Set per fermagli



MICHEL
18.3300

bestehend aus:

MICHEL Wundklammerpinzette 12 cm
WACHENFELDT Wundrandfaßpinzette
MICHEL Wundklammern 12x3 mm
Metalletui

consisting of:

MICHEL Clip Forceps
WACHENFELDT Approximation Forceps
MICHEL Clips 12x3 mm
Metal case

comprenant:

MICHEL Pince à poser agrafes
WACHENFELDT Pince à affronter
MICHEL Agrafes 12x3mm
Boîte en métal

compuesto de:

MICHEL Pinza p. poner grapas
WACHENFELDT Pinza aproximadora
MICHEL Grapas 12x3mm
Caja metálica

composto di:

MICHEL Pinza p. applicare le agrafe
WACHENFELDT Pinza per avvicinare
MICHEL Agrafe 12x3 mm
Scatola metallica



POCKET-MINI 18.3340

Nahtbesteck bestehend aus:

- 1 MATHIEU Nadelhalter 14 cm
- 1 Packung Nähseide steril
- 3 Nähnadeln, verschiedene Grössen
- 1 Nadeldose gelocht
- 1 MICHEL Wundklammerzängchen
- 20 MICHEL Wundklammern auf Halter
- 1 Skalpellgriff # 4
- 3 Skalpellklingen, verschiedene Grössen
- 1 chirurgische Schere, 13 cm, gerade sp/st
- 1 anatomische Pinzette 12,5 cm
- Metalletui

Suture Set consisting of:

- 1 MATHIEU needle holder 14 cm
- 1 package of silk, sterile
- 3 surgical needles, different sizes
- 1 needle case, perforated
- 1 MICHEL suture clip forceps
- 20 MICHEL suture clips, on clip holder
- 1 scalpel handle # 4
- 3 scalpel blades, different sizes
- 1 operating scissors 13 cm straight sh/bl
- 1 dressing forceps 12,5 cm
- metal case

Trousse à suture comprenant:

- 1 porte-aiguille MATHIEU, 14 cvm
- 1 flacon de soie à suture, stérile
- 3 aiguilles à suture, assorties
- 1 boîte pour aiguilles, perforée
- 1 pince à agrafes MICHEL
- 20 agrafes MICHEL, sur porte-agrales
- 1 manche à bistouri # 4
- 3 lames de bistouris, assorties
- 1 ciseaux 13 cm, droits, pt/mo
- 1 pince à dissection 12,5 cm
- boîte métal

Estuche para suturas compuesto de:

- 1 MATHIEU porta-agujas 14 cm
- 1 paquete de seda, estéril
- 3 agujas diferentes para suturas
- 1 cajita perforada para agujas
- 1 MICHEL pinza para agrafes
- 20 MICHEL agrafes, en dispositivo
- 1 mango de bisturi # 4
- 3 hojas diferentes de bisturi
- 1 tijera, 13 cm recta, ag./ro.
- 1 pinza de disección 12,5 cm
- caja metálica

Set per sutura composto di:

- 1 MATHIEU portaghi 14 cm
- 1 flacone de seta per sutura, sterile
- 3 aghi assortiti per sutura
- 1 astuccio per aghi, perforato
- 1 MICHEL pinza per agrafes
- 20 MICHEL agrafes, con supporto
- 1 manico per bisturi # 4
- 3 lame per bisturi, assortite
- 1 forbice chirurgica, 13 cm retta, ap/sm
- 1 pinza anatomica 12,5 cm
- contenitore metallico

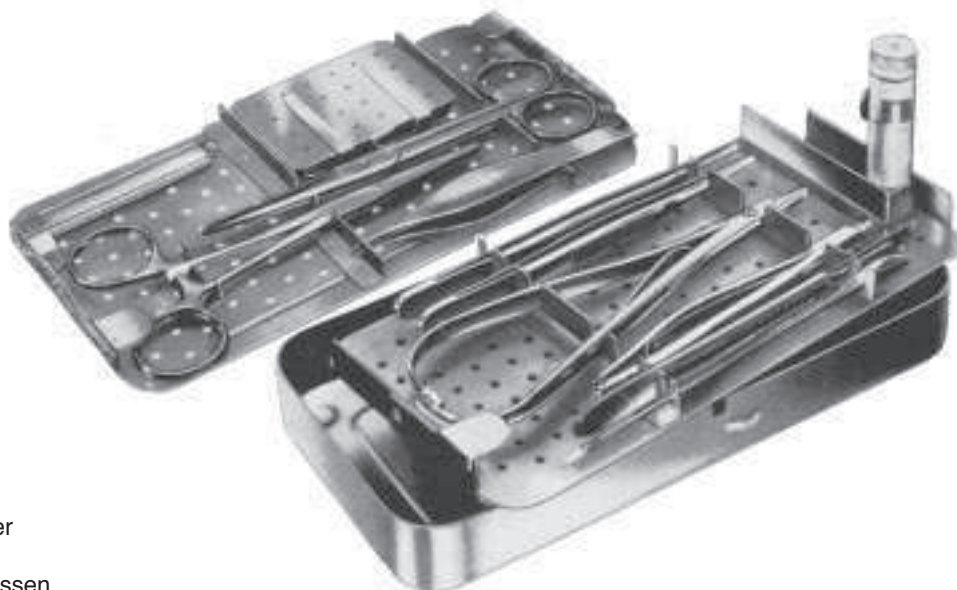

POCKET-MULTI
18.3345

Nahtbesteck bestehend aus:

- 1 MATHIEU Nadelhalter 17 cm
- 1 Packung Nähseide steril
- 6 verschiedene Nähnadeln
- 1 Nadeldose gelocht
- 1 MICHEL Wundklammerzängchen
- 20 MICHEL Wundklammern auf Halter
- 1 Skalpellgriff # 4
- 4 Skalpellklingen, verschiedene Grössen
- 1 chirurgische Schere, 14,5 cm, gerade sp/st
- 1 anatomische Pinzette 14,5 cm
- 1 chirurgische Pinzette 14,5 cm 1x2 Zähne
- 1 FEILCHENFELDT Splitterpinzette 11,5 cm
- 1 KOCHER Arterienklemme 14 cm, 1x2 Zähne
- 1 Myrtenblattsonde 13 cm
- Metalletui mit 2 herausnehmbaren Lagerungseinsätzen

Suture Set consisting of:

- 1 MATHIEU needle holder 17 cm
- 1 Package of silk, sterile
- 6 different surgical needles
- 1 needle case, perforated
- 1 MICHEL suture clip forceps
- 20 MICHEL suture clips
- 1 scalpel handle # 4
- 4 different scalpel blades
- 1 operating scissors 14,5 cm straight, sh/bl
- 1 dressing forceps 14,5 cm
- 1 dissecting forceps 14,5 cm 1x2 teeth
- 1 FEILCHENFELDT splinter forceps 11,5 cm
- 1 KOCHER artery forceps 14 cm 1x2 teeth
- 1 myrtle leaf probe 13 cm
- metal case with 2 perforated storage trays

Trousse à suture comprenant:

- 1 MATHIEU porte-aiguille 17 cm
- 1 flacon de soie à suture, stérile
- 6 aiguilles à suture, assorties
- 1 boîte pour aiguilles, perforée
- 1 MICHEL Pince à agrafes
- 20 MICHEL agrafes, sur porte-agrales
- 1 manche à bistouri # 4
- 4 lames de bistouri, assorties
- 1 ciseaux 14,5 cm, droits pt/mo
- 1 pince à dissection 14,5 cm
- 1 pince à dissection 14,5 cm 1x2 dents
- 1 FEILCHENFELDT pince à écharde 11,5 cm
- 1 KOCHER Pince hémostatique 14 cm 1x2 dents
- 1 sonde miriforme 13 cm
- boîte métal avec 2 plateaux perforés

Estuche para suturas compuesto de:

- 1 MATHIEU porta-agujas 17 cm
- 1 paquete de seda, estéril
- 6 agujas diferentes para suturas
- 1 cajita perforada para agujas
- 1 MICHEL pinza para agrafes
- 20 MICHEL agrafes, en dispositivo
- 1 mango de bisturi # 4
- 4 hojas diferentes de bisturi
- 1 tijera 14,5 cm recta ag/ro
- 1 pinza de disección 14,5 cm
- 1 pinza de disección 14,5 cm 1x2 dientes
- 1 FEILCHENFELDT Pinza para espinas 11,5 cm
- 1 KOCHER Pinza hemostática 14 cm, 1x2 dientes
- 1 sonda miriforme 13 cm
- caja metálica con 2 bandejas perforadas para instrumentos

Set per sutura composto di:

- 1 MATHIEU porthagi 17 cm
- 1 flacone di seta per sutura, sterile
- 6 aghi assortiti per sutura
- 1 astuccio per aghi, perforato
- 1 MICHEL pinza per agrafes
- 20 MICHEL agrafes, con supporto
- 1 manico per bisturi # 4
- 4 lame per bisturi, assortite
- 1 forbice chirurgica retta, 14,5 cm retta, ap/sm
- 1 pinza anatomica 14,5 cm
- 1 pinza chirurgica 14,5 cm 1x2 denti
- 1 sonda miriforme 13 cm
- caja metalica con 2 bacinelle perforate per gli strumenti

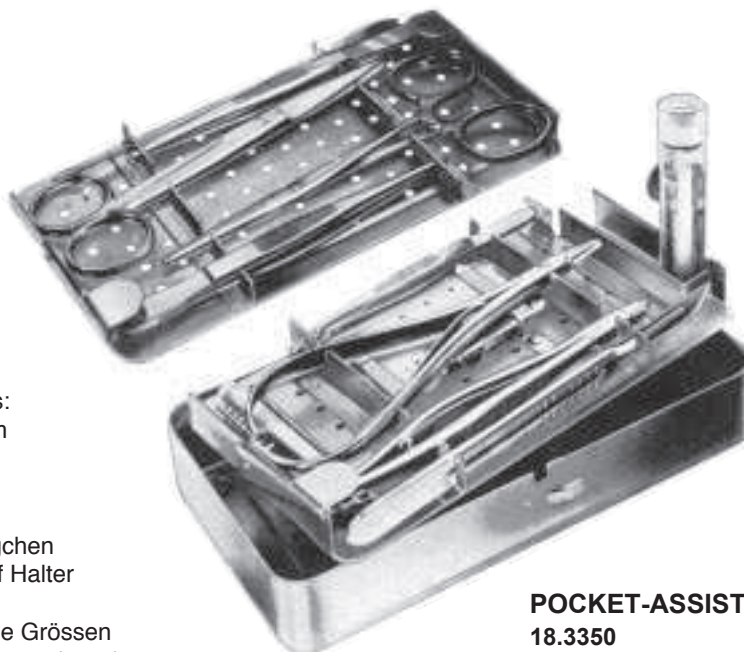

POCKET-ASSISTENT
18.3350

Taschenbesteck bestehend aus:

- 1 MATHIEU Nadelhalter 14 cm
- 1 Packung Nähseide, steril
- 6 verschiedene Nähnadeln
- 1 Nadeldose gelocht
- 1 MICHEL Wundklammerzängchen
- 20 MICHEL Wundklammern auf Halter
- 1 Skalpellgriff # 4
- 4 Skalpellklingen, verschiedene Grössen
- 1 chirurgische Schere, 13 cm, gerade sp/st
- 1 anatomische Pinzette 11,5 cm
- 1 chirurgische Pinzette 12 cm 1x2 Zähne
- 1 HUNTER Splitterpinzette 10,5 cm
- 1 KOCHER Arterienklemme 13 cm, 1x2 Zähne
- 1 Myrtenblattsonde 13 cm
- Metalletui mit 2 herausnehmbaren Lagereinsätzen

Suture Set consisting of:

- 1 MATHIEU needle holder 14 cm
- 1 Package of silk, sterile
- 6 different surgical needles
- 1 needle case, perforated
- 1 MICHEL suture clip forceps
- 20 MICHEL suture clips on clip holder
- 1 scalpel handle # 4
- 4 different scalpel blades
- 1 operating scissors 13 cm straight sh/bl
- 1 dressing forceps 11,5 cm
- 1 dissecting forceps 12 cm, 1x2 teeth
- 1 HUNTER splinter forceps 10,5 cm
- 1 KOCHER artery forceps 13 cm, 1x2 teeth
- 1 myrtle leaf probe 13 cm
- metal case with 2 perforated storage trays

Trousse à suture comprenant:

- 1 MATHIEU porte-aiguille 14 cm
- 1 flacon de soie à suture, stérile
- 6 aiguilles à suture, assorties
- 1 boîte pour aiguilles, perforée
- 1 MICHEL Pince à agrafes
- 20 MICHEL agrafes, sur porte-agrafes
- 1 manche à bistouri # 4
- 4 lames de bistouri, assorties
- 1 ciseaux 13 cm, droits pt/mo
- 1 pince à dissection 11,5 cm
- 1 pince à dissection 12 cm 1x2 dents
- 1 HUNTER pince à écharde 10,5 cm
- 1 KOCHER pince hémostatique 13 cm, 1x2 dents
- 1 sonde mirtifforme 13 cm
- boîte métal avec 2 plateaux perforés

Estuche para suturas compuesto de:

- 1 MATHIEU porta-agujas 14 cm
- 1 paquete de seda, estéril
- 6 agujas diferentes para suturas
- 1 cajita perforada para agujas
- 1 MICHEL pinza para agrafes
- 20 MICHEL agrafes, en dispositivo
- 1 mango de bisturi # 4
- 4 hojas diferentes de bisturi
- 1 tijera 13 cm recta ag/ro
- 1 pinza de disección 11,5 cm
- 1 pinza de disección 12 cm 1x2 dientes
- 1 HUNTER pinza para espinas 10,5 cm
- 1 KOCHER pinza hemostática 13 cm, 1x2 dientes
- 1 Sonda miritforme 13 cm
- caja metálica con 2 bandejas perforadas para instrumentos

Set per sutura composto di:

- 1 MATHIEU porthagi 14 cm
- 1 flacone di seta per sutura, sterile
- 6 aghi assortiti per sutura
- 1 astuccio per aghi, perforato
- 1 MICHEL pinza per agrafes
- 20 MICHEL agrafes, con supporto
- 1 manico per bisturi # 4
- 4 lame per bisturi, assortite
- 1 forbice chirurgica, 13 cm retta, ap/sm
- 1 pinza anatomica 11,5 cm
- 1 pinza chirurgica 12 cm 1x2 denti
- 1 HUNTER pinza per scheggie 10,5 cm
- 1 KOCHER pinza emostatica 13 cm, 1x2 denti
- 1 Sonda miritforme 13 cm
- scatola metallica con 2 bacinelle perforate per gli strumenti

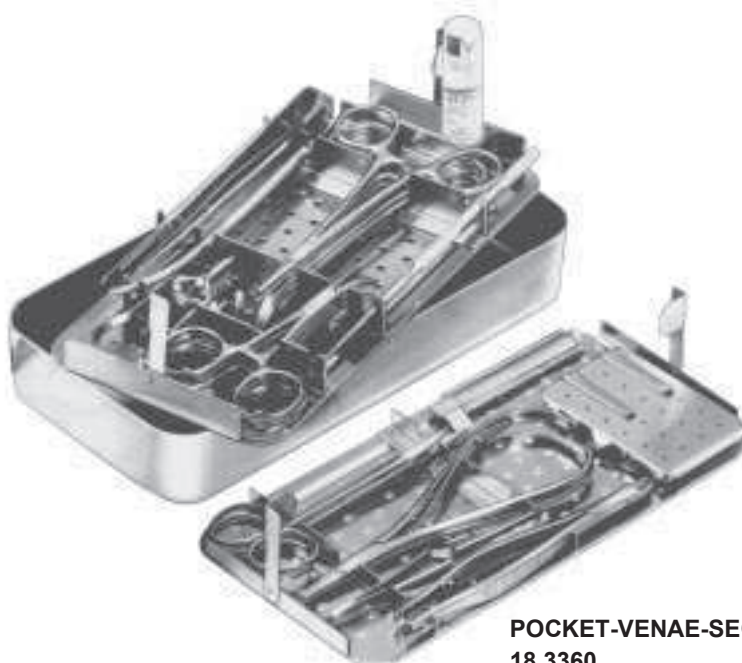

POCKET-VENAE-SECTIO
18.3360

Venae-Sectio Besteck bestehend aus:

- 1 Skalpellgriff # 4
- 4 verschiedene Skalpellklingen
- 1 Gefäßschere 11,5 cm gerade mit Knopfende
- 1 Schere 10,5 cm gebogen sp/sp
- 1 SEMKEN anatomische Pinzette 12 cm
- 1 SEMKEN chirurgische Pinzette 12 cm 1x2 Zähne
- 2 MOSQUITO Arterienklammern 12,5 cm gebogen
- 2 MOSQUITO Arterienklammern 12,5 cm gerade 1x2 Zähne
- 3 BACKHAUS Tuchklammern 8 cm
- 1 FINSEN Wundsperrer 7 cm, feststellbar
- 1 DOYEN Hohlsonde 14 cm, gebogen
- 1 MATHIEU Nadelhalter 14 cm
- 3 verschiedene Nähnadeln
- 1 Nadeldose gelocht
- 1 LANGE Wundbrandpinzette 10 cm, selbsthaltend
- 1 MICHEL Wundklammerzängchen
- 20 MICHEL Wundklammern auf Halter
- 1 Unterbindungsnadel fein
- Metalletui mit 2 herausnehmbaren Lagereinsätzen

Venae-Sectio Set consisting of:

- 1 scalpel handle # 4
- 4 different scalpel blades
- 1 vascular scissors 11,5 cm straight, button-end
- 1 scissors 10,5 cm curved, sh/sh
- 1 SEMKEN dressing forceps 12 cm
- 1 SEMKEN dissecting forceps 12 cm, 1x2 teeth
- 2 MOSQUITO artery forceps 12,5 cm, curved
- 2 MOSQUITO artery forceps 12,5 cm, straight, 1x2 teeth
- 3 BACKHAUS towel clamps 8 cm
- 1 FINSEN spreader 7 cm, adjustable
- 1 DOYEN grooved director 14 cm, curved
- 1 MATHIEU needle holder 14 cm
- 3 different surgical needles
- 1 needle case, perforated
- 1 LANGE approximation forceps 10 cm
- 1 MICHEL suture clip forceps
- 20 MICHEL suture clips on clip holder
- 1 ligature needle, delicate
- metal case with 2 perforated storage trays

Trouse pour venae sectio comprenant:

- 1 manche à bistouri # 4
- 4 lames de bistouri, assorties
- 1 ciseaux vasculaires aboutonnés, 11,5 cm droits
- 1 ciseaux 10,5 cm courbes pt/pt
- 1 SEMKEN pince à dissection 12 cm
- 1 SEMKEN pince à dissection 12 cm, 1x2 dents
- 2 MOSQUITO pinces hémostatiques 12,5 cm courbes
- 2 MOSQUITO pinces hémostatiques 12,5 cm droites, 1x2 dents
- 3 BACKHAUS pinces à champs 8 cm
- 1 FINSEN écarteur 7 cm, arrêtant
- 1 DOYEN sonde cannelée 14 cm courbe
- 1 MATHIEU porte-aiguille 14 cm
- 3 aiguilles à suture, assorties
- 1 boîte pour aiguilles, perforée
- 1 LANGE pince pour les bords de la plaie, autostatique
- 1 MICHEL Pince à agrafes
- 20 MICHEL agrafes sur porte-agrales
- 1 aiguille à ligatures, fine
- boîte métal avec 2 plateaux perforés

Estuche para Venaesectio compuesto de:

- 1 mango de bisturi # 4
- 4 hojas diferentes de bisturi
- 1 tijera vascular, recta, abotonada, 11,5 cm
- 1 tijera 10,5 cm curva ag/ro
- 1 SEMKEN pinza de disección, 12 cm
- 1 SEMKEN pinza de disección 12 cm 1x2 dientes
- 2 MOSQUITO pinzas hemostáticas, recta 1x2 dientes
- 3 BACKHAUS pinzas de campo 8 cm
- 1 FINSEN separador, ajustable, 7 cm
- 1 DOYEN sonda acanalada, curva, 14 cm
- 1 MATHIEU porta-agujas 14 cm
- 3 agujas diferentes para suturas
- 1 cajita perforada para agujas
- 1 cajita perforada para agujas
- 1 LANGE pinza aproximadora, autostática, 10 cm
- 1 MICHEL pinza para agrafes
- 20 MICHEL agrafes, en dispositivo
- 1 aguja para ligaduras, fina
- caja metálica con 2 bandejas perforadas para instrumentos

Set per venae sectio composto di:

- 1 manico per bisturi # 4
- 4 lame per bisturi, assortite
- 1 forbice vascolare con punte a bottone 11,5 cm retta
- 1 forbice 10,5 cm, curve ac/ac
- 1 SEMKEN pinza anatomica 12 cm
- 1 SEMKEN pinza chirurgica 12 cm, 1x2 denti
- 2 MOSQUITO pinze emostatiche 12,5 cm curve
- 2 MOSQUITO pinze emostatiche 12,5 cm rette, 1x2 denti
- 3 BACKHAUS pinze fissatelli 8 cm
- 1 FINSEN divaricatore 7 cm, regolabile
- 1 DOYEN sonda cannulata 14 cm, curva
- 1 MATHIEU portaghi 14 cm
- 3 aghi assortiti per sutura
- 1 astuccio per aghi, perforato
- 1 LANGE pinza per i bordi della ferita autostatica
- 1 MICHEL pinza per agrafes
- 20 MICHEL agrafes con porte-agrales
- 1 ago per legatura, fino
- contenitore metallico con 2 bacinelle perforate per gli strumenti



REVERDIN
18.4001 – 18.4034



1

18.4001 15 cm
18.4011 19 cm
18.4021 21 cm
18.4031 23 cm



2

18.4002 15 cm
18.4012 19 cm
18.4022 21 cm
18.4032 23 cm



3

18.4003 15 cm
18.4013 19 cm
18.4023 21 cm
18.4033 23 cm



4

18.4004 15 cm
18.4014 19 cm
18.4024 21 cm
18.4034 23 cm

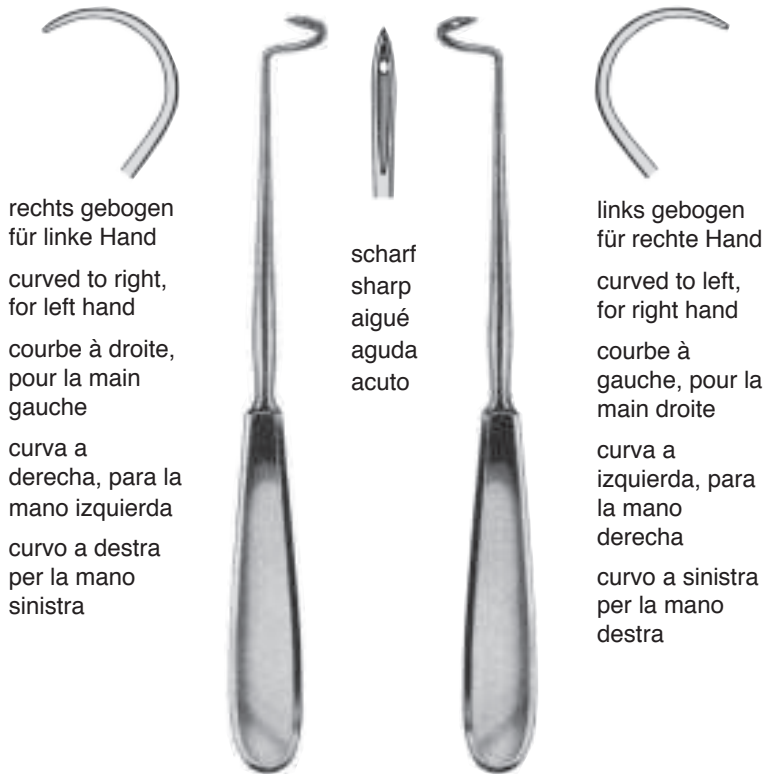

rechts gebogen
für linke Hand

curved to right,
for left hand

courbe à droite,
pour la main
gauche

curva a
derecha, para la
mano izquierda

curvo a destra
per la mano
sinistra

scharf
sharp
aigué
aguda
acuto

links gebogen
für rechte Hand

curved to left,
for right hand

courbe à
gauche, pour la
main droite

curva a
izquierda, para
la mano
derecha

curvo a sinistra
per la mano
destra

DESCHAMPS

18.4100	21 cm	18.4101
18.4104	24 cm	18.4105
18.4108	27 cm	18.4109

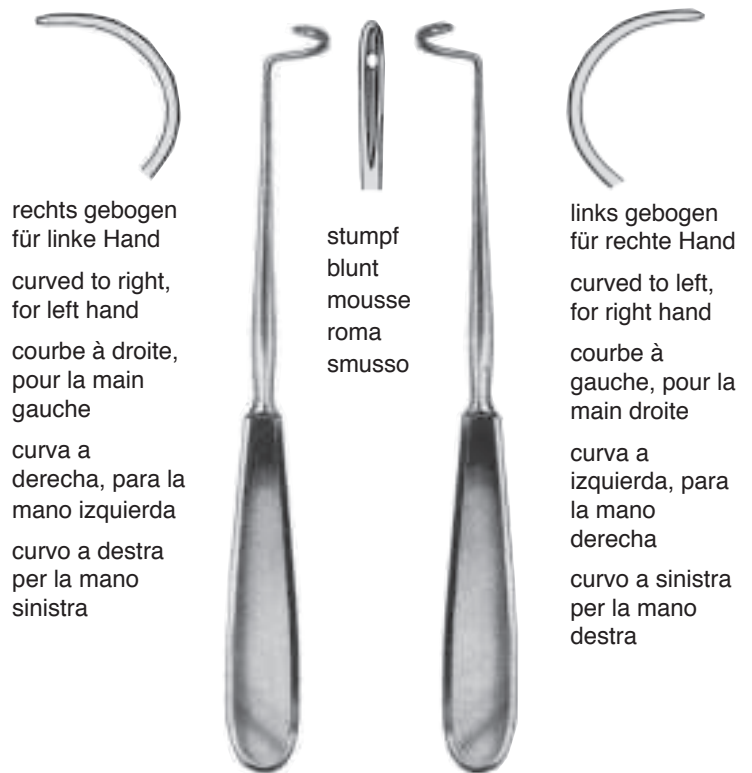

rechts gebogen
für linke Hand

curved to right,
for left hand

courbe à droite,
pour la main
gauche

curva a
derecha, para la
mano izquierda

curvo a destra
per la mano
sinistra

stumpf
blunt
mousse
roma
smusso

links gebogen
für rechte Hand

curved to left,
for right hand

courbe à
gauche, pour la
main droite

curva a
izquierda, para
la mano
derecha

curvo a sinistra
per la mano
destra

DESCHAMPS

18.4102	21 cm	18.4103
18.4106	24 cm	18.4107
18.4110	27 cm	18.4111



links gebogen
für rechte Hand
curved to left,
for right hand
courbe à
gauche, pour la
main droite
curva a
izquierda, para
la mano
derecha
curvo a sinistra
per la mano
destra

KRONECKER
18.4130 13 cm

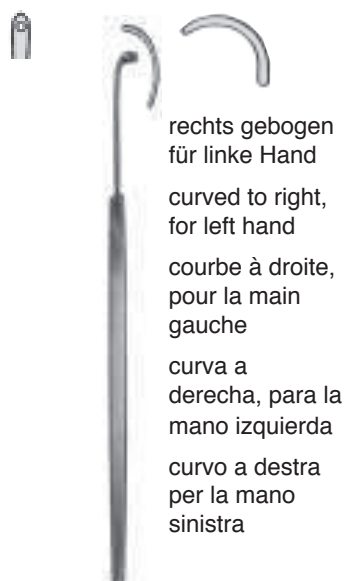

rechts gebogen
für linke Hand
curved to right,
for left hand
courbe à droite,
pour la main
gauche
curva a
derecha, para la
mano izquierda
curvo a destra
per la mano
sinistra

KRONECKER
18.4131 13 cm



links gebogen
für rechte Hand
curved to left,
for right hand
courbe à
gauche, pour la
main droite
curva a
izquierda, para
la mano
derecha
curvo a sinistra
per la mano
destra

KRONECKER
18.4132 13 cm



rechts gebogen
für linke Hand
curved to right,
for left hand
courbe à droite,
pour la main
gauche
curva a
derecha, para la
mano izquierda
curvo a destra
per la mano
sinistra

KRONECKER
18.4133 13 cm



biegsam
malleable
malléable
maleable
malleabili

LIGATURE
18.4140 19 cm

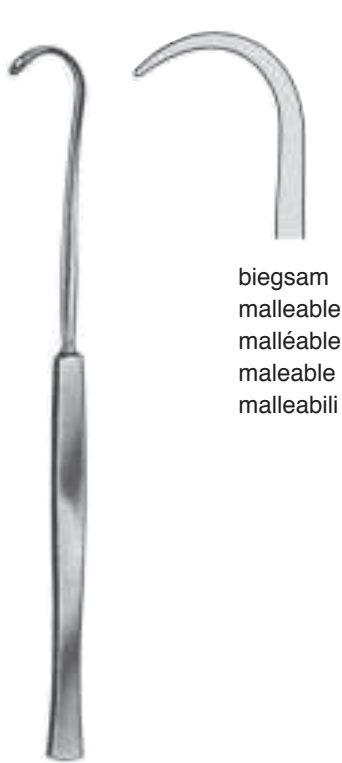

biegsam
malleable
malléable
maleable
malleabili

COOPER
18.4150 20 cm



18.4190 #1

18.4191 #2

BRUNNER
30 cm



PAYR
18.4211 20 cm



PAYR
18.4212 22 cm



PAYR
18.4213 22 cm



KOENIG



18.4241
19 cm / 3 mm



18.4243
19 cm / 5 mm



18.4245
20 cm / 7 mm



18.4261
1

18.4263
2

BRUNNER
30 cm

Fadengabel
Ligature fork
Pousse-fil
Horquilla para ligaduras
Forchetta da sutura



BRUNNER-FERROZELL
18.4301 18 cm
18.4303 27 cm

FERROZELL
18.4340 19 cm
gerade/straight
droite/rectas/retto
18.4341 19 cm
gebogen/curved
courbe/curvas/curvo



LIGATURE
18.4250 23 cm



MOD. WIEN
18.4255 23,5 cm

Fadenfänger
Suture catcher
Porte-ligature
Porta-ligadura
Portalegature